

new

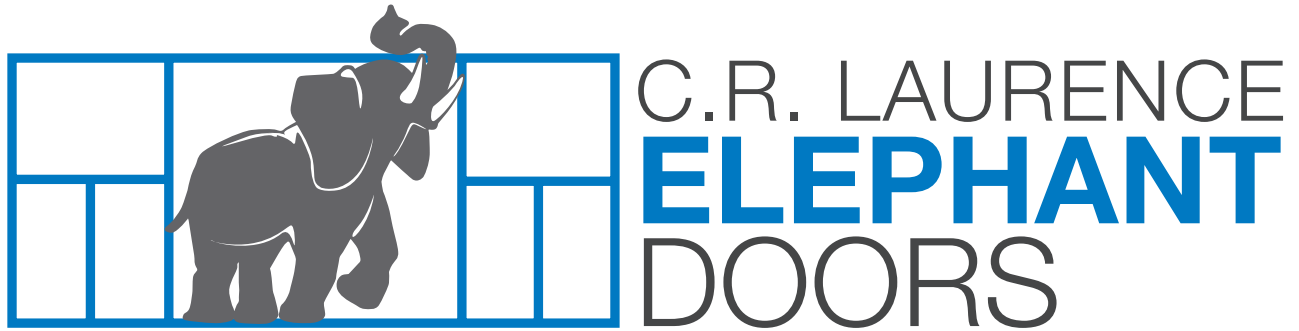

An Operable Storefront System With Functioning Doors

SECTION H8	PAGE
SPECIFICATIONS.....	02-H8
TECHNICAL DATA.....	03-H8
SPECIAL FEATURES.....	04-H8
TYPICAL DETAILS.....	05-H8 thru 08-H8

Due to the diversity in state/provincial, local, and federal laws and codes that govern the design and application of architectural products, it is the responsibility of the individual architect, owner, and installer to ensure that products selected for use on projects comply with all applicable building codes and laws. U.S. Aluminum exercises no control over the use or application of its products, glazing materials, and operating hardware, and assumes no responsibility thereof.

The rapidly changing technology within the architectural aluminum products industry demands that U.S. Aluminum reserve the right to revise, discontinue or change any product line, specification or electronic media without prior written notice.

NOTE: Dimensions in parentheses () are millimeters unless otherwise noted.

- Other metric units shown in this publication are:
- m - meter
 - Pa - pascal
 - MPa - megapascal
 - Kg - kilogram
 - KPa - kilopascal

ENTRANCES

Specifications

Elephant Sliding Doors • Series E1200

SECTION 08 43 29 SLIDING STOREFRONTS

new

SERIES	FACE WIDTH	DEPTH	GLAZING INFILLS	GLAZING METHOD
E1200	4-1/2" (114.3)	6-1/2" (165.1)	1/4" (6) or 1" (25)	Interior

I. GENERAL DESCRIPTION

Work Included: The glazing contractor shall furnish all necessary materials, labor, and equipment for the complete installation of aluminum sliding doors as detailed on the drawings and specified herein.

Work Not Included: Structural support of the framing system, wood framing, structural steel, masonry and final cleaning.

QUALITY ASSURANCE

Drawings and specifications are based on U.S. Aluminum Series E1200 Elephant Sliding Doors. Whenever substitute products are to be considered, supporting technical literature, samples, drawings, and performance data must be submitted 10 days prior to bid in order to make a valid comparison of the products involved.

PERFORMANCE REQUIREMENTS

Structural Performance: shall be tested in accordance with ASTM E 330 and based on:

- Maximum deflection of L/204 of the span
- Allowable stress with a safety factor of 1.65

The system shall perform to this criteria under a windload of (*Specify*) psf.

II. PRODUCTS MATERIALS

Extrusions shall be 6063-T5 alloy and temper (ASTM B221 alloy T5 temper). Fasteners, where exposed, shall be aluminum, stainless steel or zinc plated steel in accordance with ASTM A 164. Perimeter anchors shall be aluminum

or steel, providing the steel is properly isolated from the aluminum. Glazing gaskets shall be E.P.D.M. elastomeric extrusions. Door shall have a minimum wall thickness of 3/16" (4.8).

FINISH

All exposed framing surfaces shall be free of scratches and other serious blemishes. Aluminum extrusions shall be given a caustic etch followed by an anodic oxide treatment to obtain...

(Specify one of the following):

- _____ #11 Clear anodic coating
- _____ #22 Dark Bronze anodic coating
- _____ #33 Black anodic coating

A Fluoropolymer paint coating conforming with the requirements of AAMA 2605. Color shall be (Specify a U.S. Aluminum standard color).

FABRICATION

The framing system shall provide for flush glazing on all sides with no projecting stops. Vertical and horizontal framing members shall have a nominal face dimension of 4-1/2" (114.3). Overall depth shall be 6-1/2" (165.1). Elephant Entrance framing members shall be constructed with clip joinery to vertical mullions. Sliding panels shall be supported by aluminum base tracks equipped with four tandem ball bearing rollers, each roller capable of supporting 800 pounds (363 Kg).

OPTIONAL: Aluminum Swing Entrance.

A. Hardware:

1. Weatherstripping: The active meeting stile of all pair of doors

shall have an adjustable astragal with double line of weatherstripping.

2. Threshold: Extruded aluminum, one piece per door opening.
3. Continuous geared hinges.
4. Standard push/pull handle set.
5. Jackson overhead closer.
6. _____ Deadbolt Lock.
7. _____ Flush Bolts.
8. Cylinder(s).
9. Thumbturn-interior [optional].
10. Cylinder guard [optional].

III. EXECUTION INSTALLATION

All glass framing shall be set in correct locations as shown in the details and shall be level, square, plumb, and in alignment with other work in accordance with the manufacturer's installation instructions and approved shop drawings. All joints between framing and the building structure shall be sealed in order to secure a watertight installation.

PROTECTION AND CLEANING

After installation the General Contractor shall adequately protect exposed portions of aluminum surfaces from damage by grinding and polishing compounds, plaster, lime, acid, cement or other contaminants. The General Contractor shall be responsible for final cleaning.

Technical Data

Elephant Sliding Doors

• Series E1200

new

TYPICAL APPLICATIONS:

- Mall Fronts
- Car, Truck, and Boat Dealerships
- Convention Centers
- Museums
- Sports Venues
- Gymnasiums
- Performing Arts Facilities

The Series E1200 Elephant Door Operable Storefront System is a sliding/pivoting entrance system designed and engineered with versatility and economics in mind. This system is ideally suited for monumental applications requiring a sliding storefront with functional pivoting doors. Its rugged overall construction coupled with heavy wall stiles and interlocks, heavy-duty tandem rollers, and a concealed floor track, offers smooth operation and durability. Pivoting doors can be equipped with overhead concealed closers, cylinder locks, pulls or panics. Various configurations are available to meet your design needs. The E1200 is intended for installations that have soffit overhangs greater than the overall entrance frame height. Local codes should be checked for compliance.

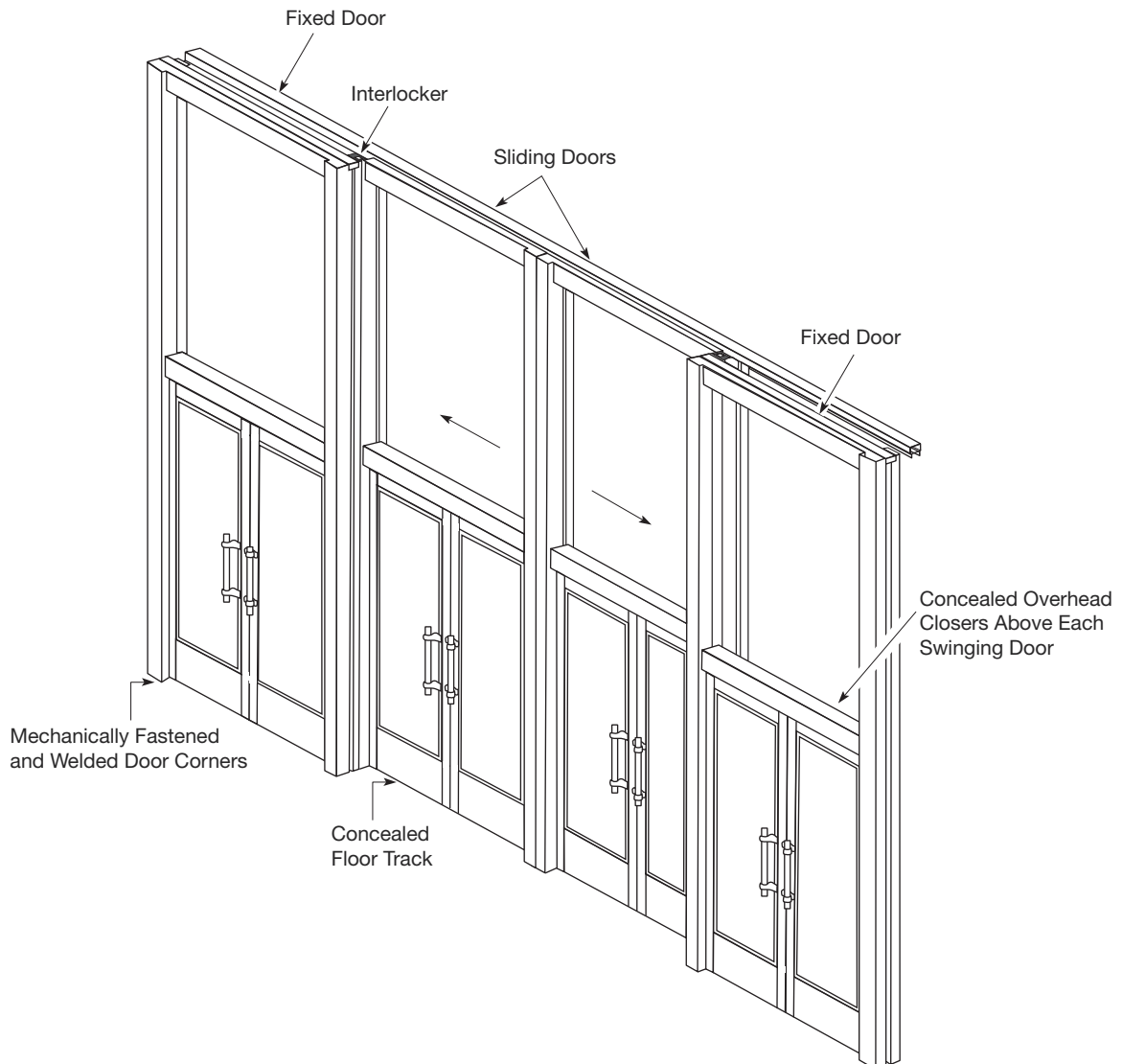

ENTRANCES

Special Features

Elephant Sliding Doors

- Series E1200

- Sliding Storefront
- Recessed Floor Track
- "Elephant Size" Opening
- Interlocking Panels

new



In the Closed Position It's Business as Usual with Pairs of Swinging Entrance Doors.



With the Sliding Doors Open, the "Elephant Size" Opening Allows for Larger Objects to be Moved In or Out.

Online usalum.com By Phone (800) 262-5151 Ext. 5305
 Online crlaurence.com By Phone (800) 421-6144 Ext. 5305

Typical Details

Elephant Sliding Doors

• Series E1200

**DOOR FRAMING
FOR 1/4" (6) AND 1" (25) GLAZING**

NOTE: NP225 Glazing Gaskets used on both sides of glass. (Typical) Shown with Series 400 Medium Stile Doors. Available with other Series Doors upon request.

new

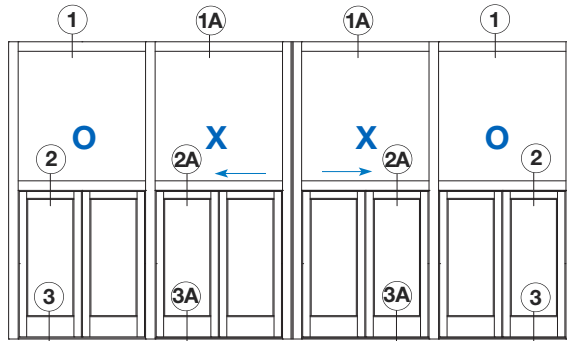

TYPICAL ELEVATION

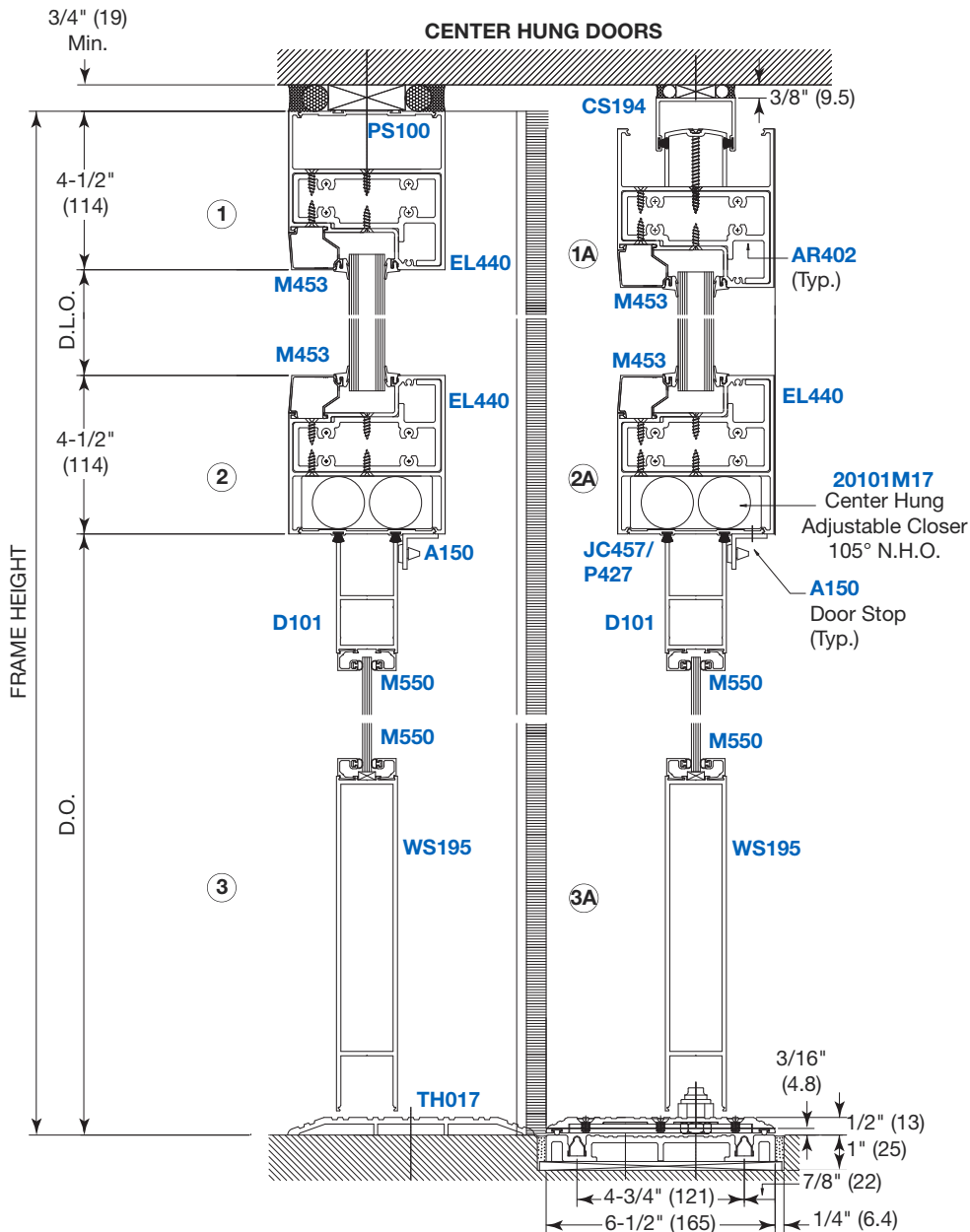

NOT TO SCALE

Online usalum.com By Phone (800) 262-5151 Ext. 5305
Online crlaurence.com By Phone (800) 421-6144 Ext. 5305

ENTRANCES

Typical Details

Elephant Sliding Doors • Series E1200

**DOOR FRAMING
FOR 1/4" (6) AND 1" (25) GLAZING**

new

NOTE: NP225 Glazing Gaskets used on both sides of glass. (Typical) Shown with Series 400 Medium Stile Doors. Available with other Series Doors upon request.

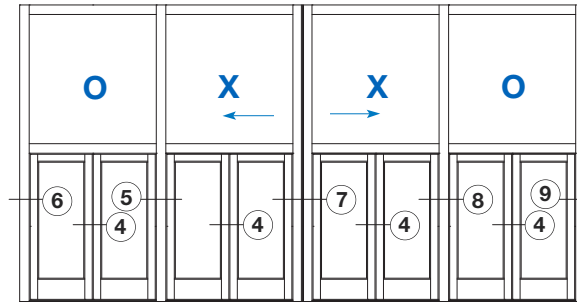

TYPICAL ELEVATION

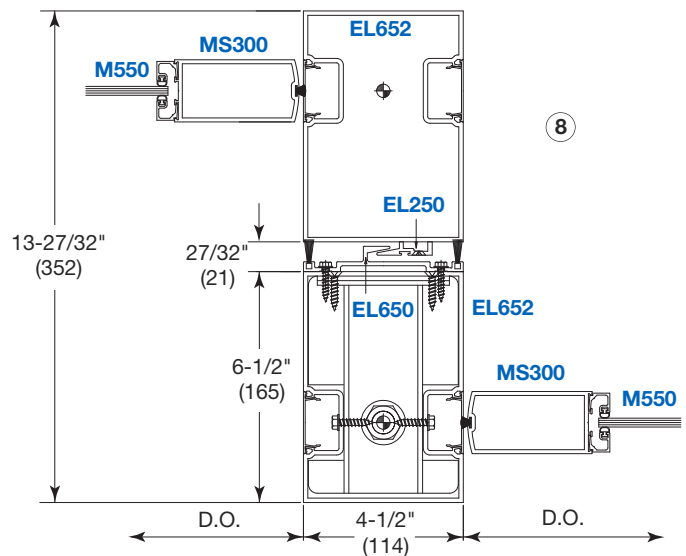
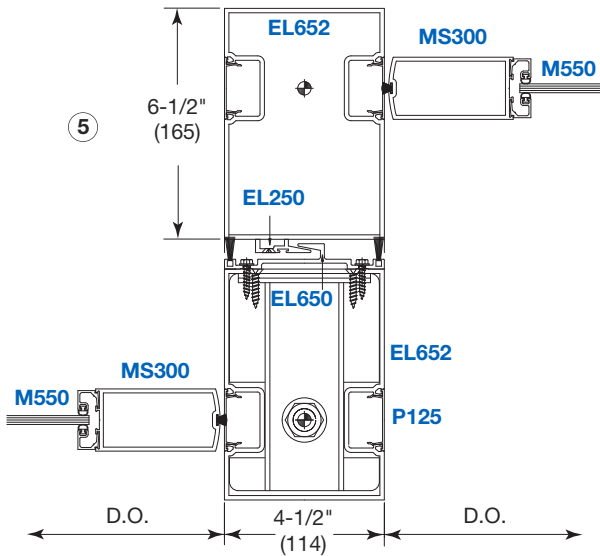

NOT TO SCALE

Online usalum.com By Phone (800) 262-5151 Ext. 5305
Online crlaurence.com By Phone (800) 421-6144 Ext. 5305

Typical Details

Elephant Sliding Doors
• Series E1200

new

DOOR FRAMING
FOR 1/4" (6) AND 1" (25) GLAZING

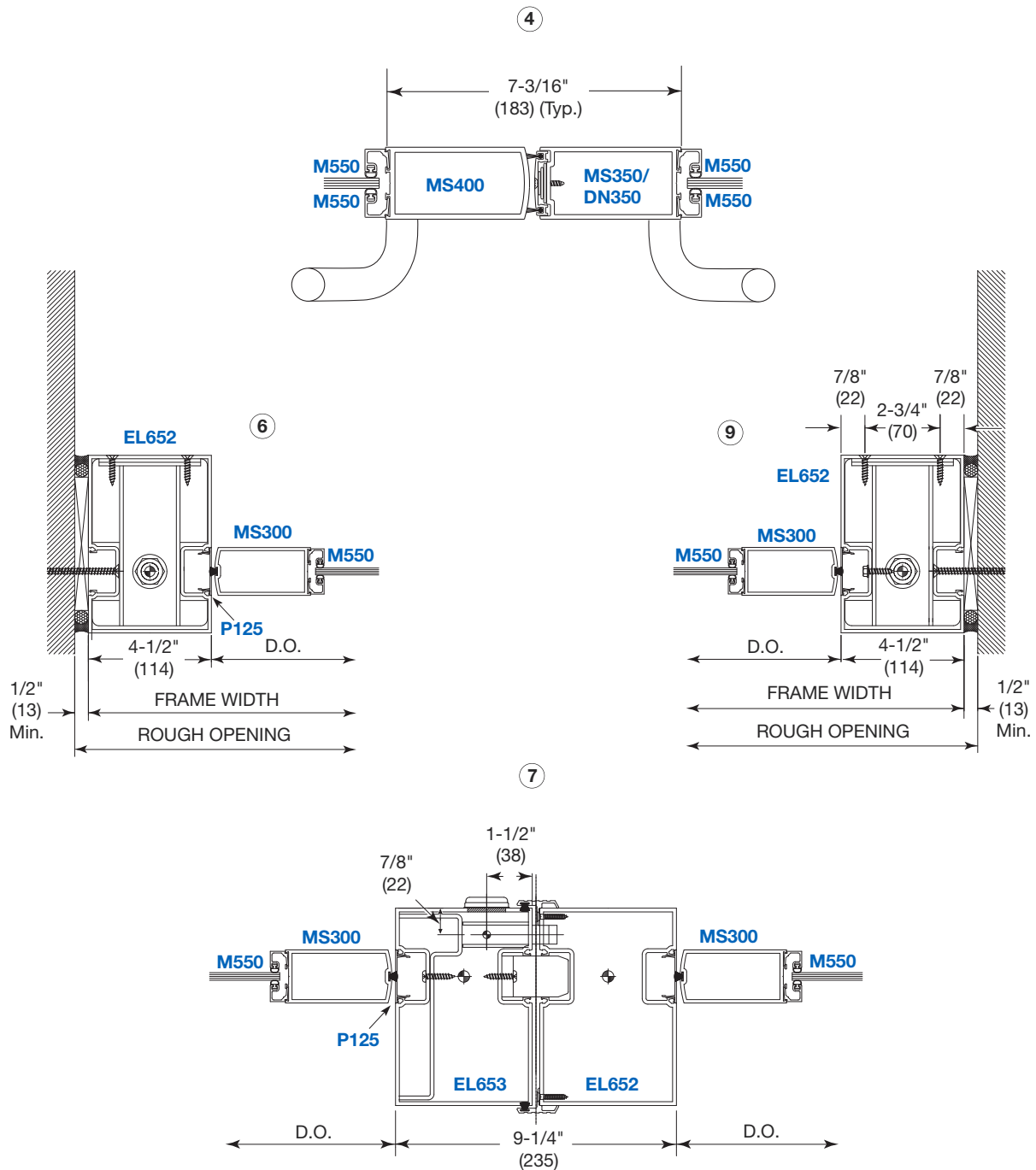

NOT TO SCALE

Online usalum.com By Phone (800) 262-5151 Ext. 5305
Online crlaurence.com By Phone (800) 421-6144 Ext. 5305

ENTRANCES

Typical Details

Elephant Sliding Doors • Series E1200

new

**DOOR FRAMING
FOR 1/4" (6) AND
1" (25) GLAZING**

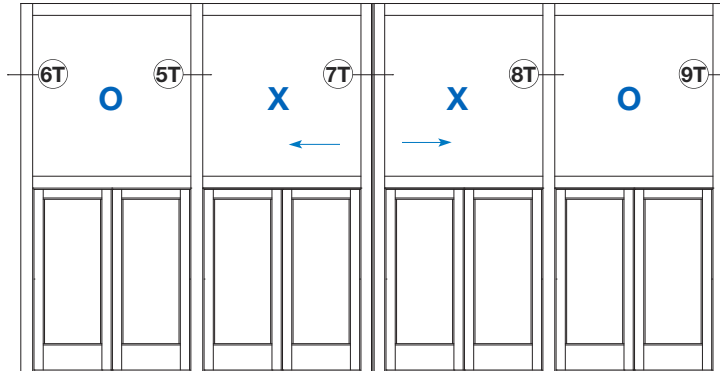

TYPICAL ELEVATION

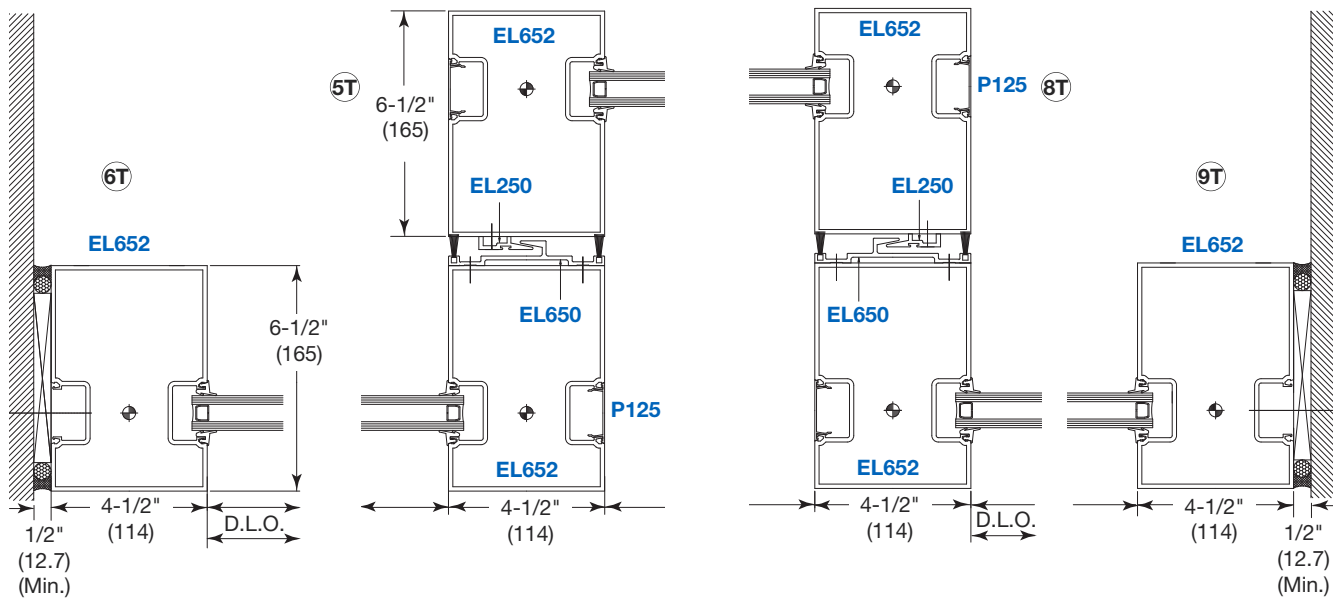
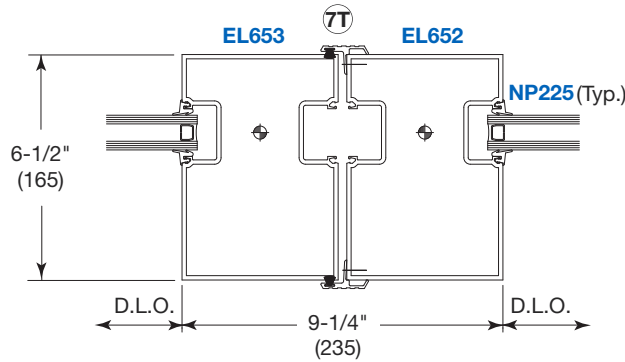

NOT TO SCALE

Online usalum.com By Phone (800) 262-5151 Ext. 5305
Online crlaurence.com By Phone (800) 421-6144 Ext. 5305